

Data Sheet



Article number: 23110111035

Description: E+G Column level indicator
HCK.254-GL-M12, for glycol-based solutions

Measures

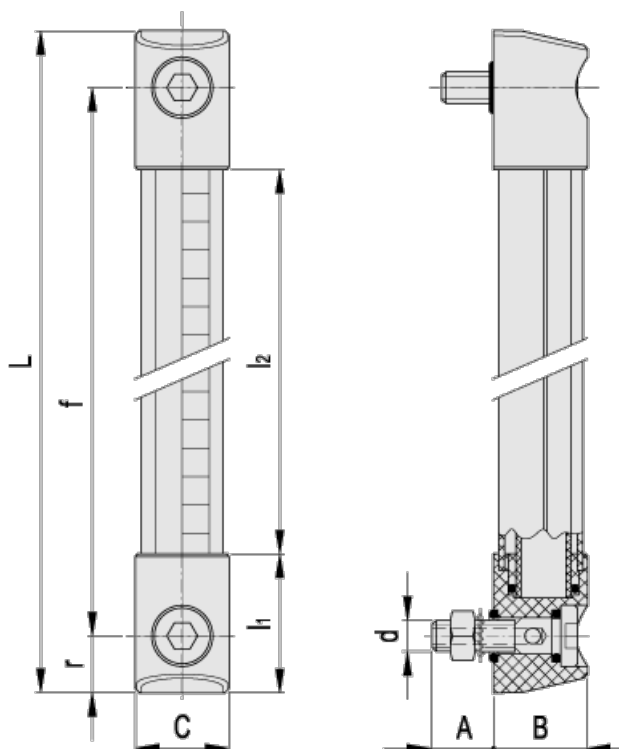

A = 20

r = 18.5

B = 33

C = 33

d = M12

f = 254

L = 291

l1 = 46.5

l2 = 198